

Amg

Industries

Des compétences certifiées



PROFILES ALUMINIUM

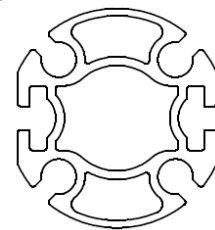
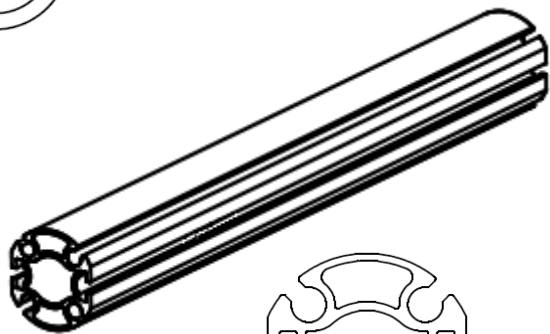
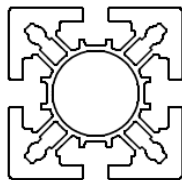
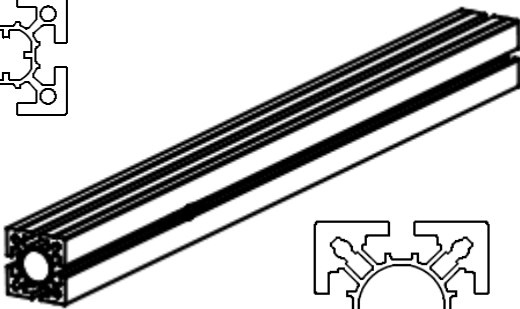
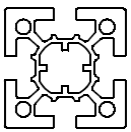
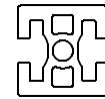
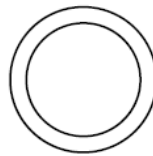
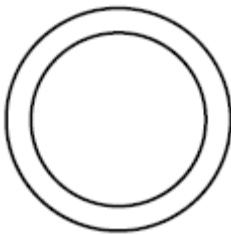
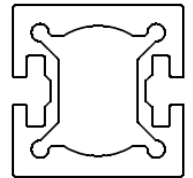
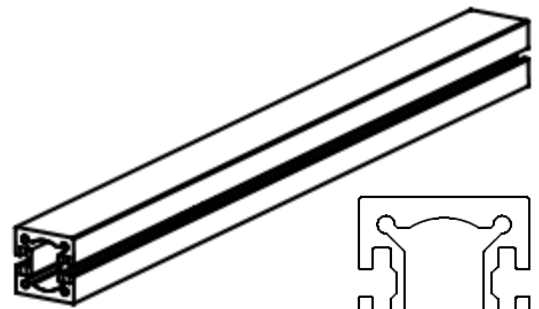
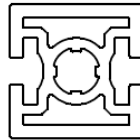

2012

SOMMAIRE	2
PROFILES ALUMINIUM SECTION 30x30.....	3
PROFILES ALUMINIUM SECTION 40x40.....	4
PROFILES ALUMINIUM SECTION 50x50.....	5
PROFILES ALUMINIUM SECTION 75.....	6
PROFILES ALUMINIUM SECTION RONDE.....	7

La plupart de nos produits sont protégés par brevets internationaux.

Toute fabrication sans autorisation écrite de la société AMG est strictement interdite.

Nous nous réservons le droit de modifier sans préavis tous les éléments présents dans cette brochure.

Section 30x30 réf. PRS 11 301

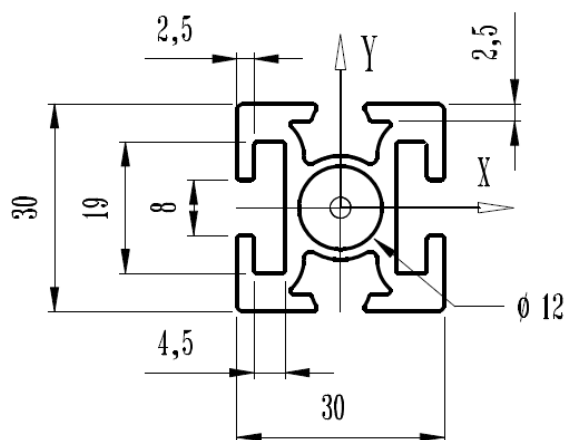
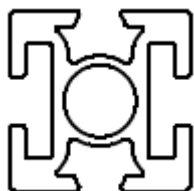

Masse : 1,09 kg/m

REFERENCES	LONGUEUR (m)	MASSE (Kg)
PRS 11 301 3M	3	3,27
PRS 11 301 6M	6	6,54

(Autres longueurs sur demande)

Section 30x30 renforcée réf. PRS 11 302

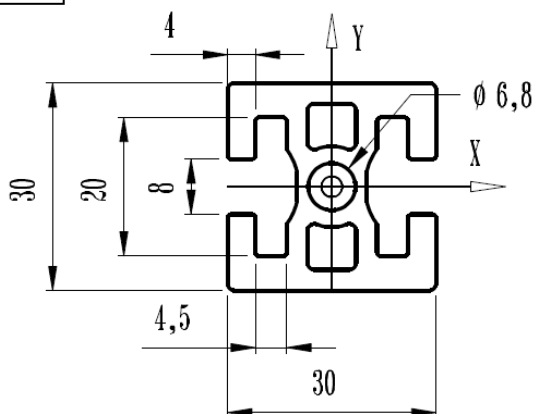
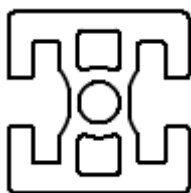

Masse : 1,37 kg/m

REFERENCES	LONGUEUR (m)	MASSE (Kg)
PRS 11 302 3M	3	4,17
PRS 11 302 6M	6	8,34

(Autres longueurs sur demande)

Section 40x40 réf. PRS 11 401

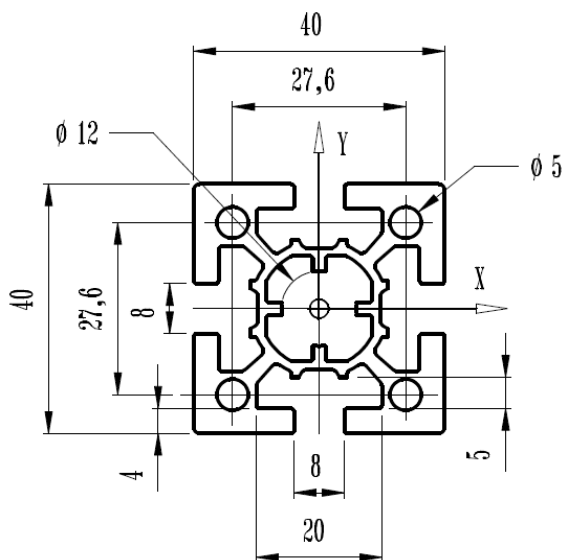
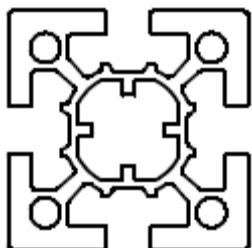

Masse : 1,83 kg/m

REFERENCES	LONGUEUR (m)	MASSE (Kg)
PRS 11 401 3M	3	5,49
PRS 11 401 6M	6	10,98

(Autres longueurs sur demande)

Section 40x40 renforcée réf. PRS 11 402

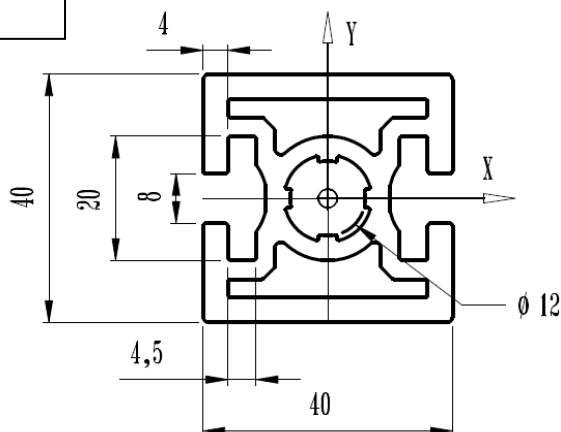
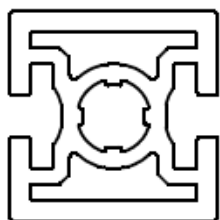

Masse : 2,28 kg/m

REFERENCES	LONGUEUR (m)	MASSE (Kg)
PRS 11 402 3M	3	6,84
PRS 11 402 6M	6	13,68

(Autres longueurs sur demande)

Section 50x50 réf. PRS 11 501

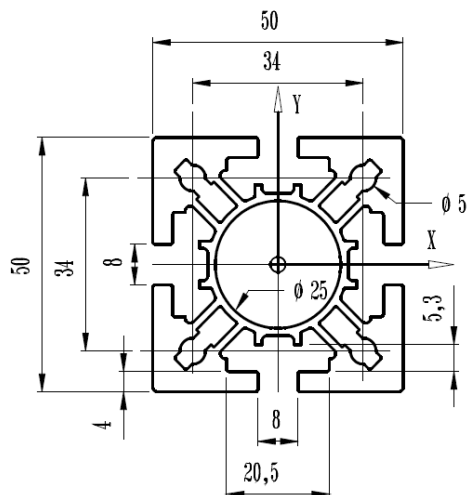
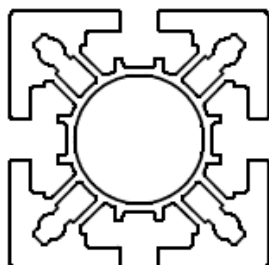

Masse : 2,83 kg/m

REFERENCES	LONGUEUR (m)	MASSE (Kg)
PRS 11 501 3M	3	8,49
PRS 11 501 6M	6	16,98

(Autres longueurs sur demande)

Section 50x50 renforcée réf. PRS 11 502

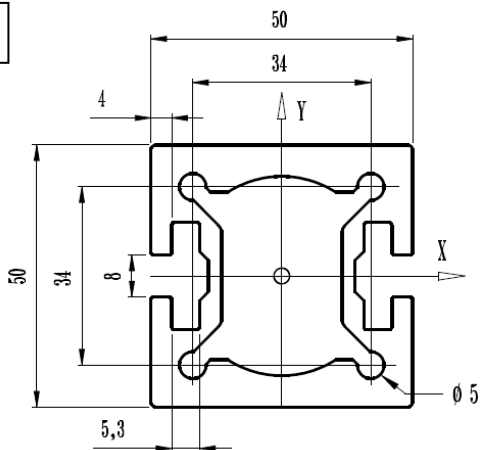
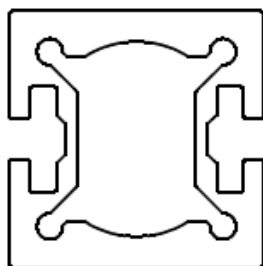

Masse : 3,26 kg/m

REFERENCES	LONGUEUR (m)	MASSE (Kg)
PRS 11 502 3M	3	10,68
PRS 11 502 6M	6	21,36

(Autres longueurs sur demande)

Section dia 75 réf. PRS 11 075

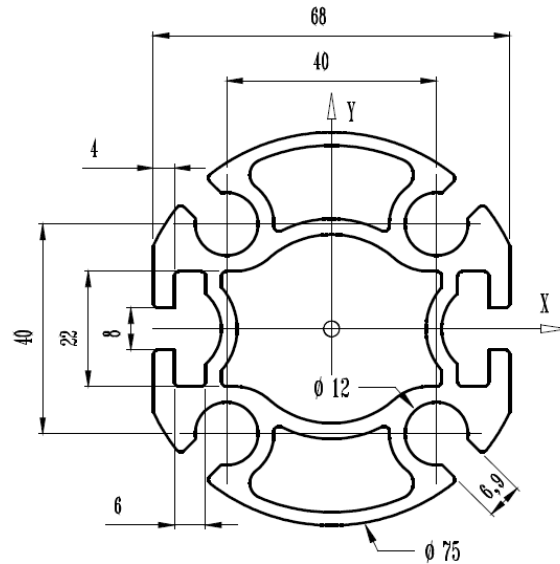
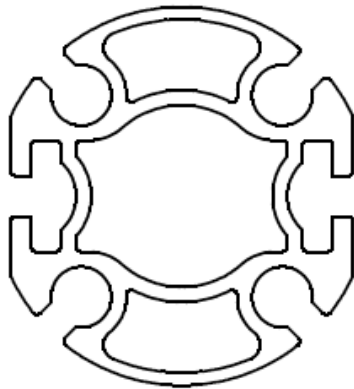

Masse: 3,88 kg/m

REFERENCES	LONGUEUR (m)	MASSE (Kg)
PRS 11 075 3M	3	11,64
PRS 11 075 6M	6	23,28

(Autres longueurs sur demande)

Section dia 25 réf. PRS 01 025

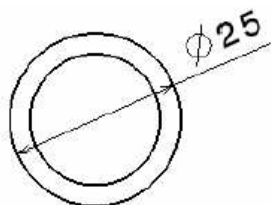

Masse : 0,86 kg/m
Ep. 5mm

REFERENCES	LONGUEUR (m)	MASSE (Kg)
PRS 01 025 3M	3	2,58
PRS 01 025 6M	6	5,16

(Autres longueurs sur demande)

Section dia 40 réf. PRS 01 040

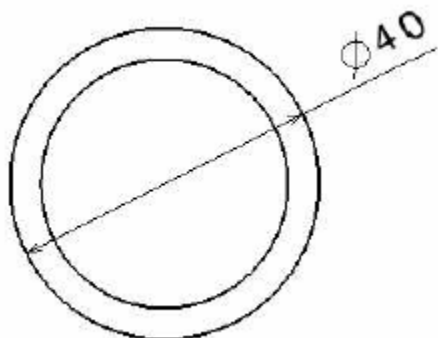

Masse : 1,48 kg/m
Ep. 5mm

REFERENCES	LONGUEUR (m)	MASSE (Kg)
PRS 01 040 3M	3	4,44
PRS 01 040 6M	6	8,88

(Autres longueurs sur demande)

Section dia 60 réf. PRS 01 060

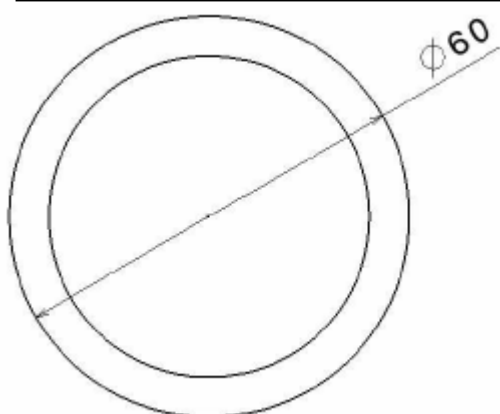

Masse : 2,75 kg/m
Ep. 6mm

REFERENCES	LONGUEUR (m)	MASSE (Kg)
PRS 01 060 3M	3	8,55
PRS 01 060 6M	6	17,10

(Autres longueurs sur demande)



AMG Industries
Zone Artisanale - BP 20
27220 GROSSOEUVRE France



STANDARD : +33 (0)2 32 32 86 86



Fax : +33 (0)2 32 32 86 87



accueil@amg-sa.com



www.amg-sa.com